

ISLA

ISS265

Isla 6" Showerhead with 8" Wall Mounted 45 Degree Shower Arm



SHOWN IN ISLA 6" SHOWERHEAD WITH 8" WALL MOUNTED 45 DEGREE SHOWER ARM | ISS265

TECHNICAL DETAILS

Adjustable Versus Fixed Spray: Fixed
Fittings Hole Diameter: 1 1/4"
Inlet Connection Size: 1/2"
Inlet Connection Type: Male NPT
Pivot: Y
Primary Material: Brass
Restricted Maximum Flow Rate: 1.75 gpm
Water Pressure Maximum: 85.0 psi
Water Pressure Minimum: 20.0 psi
Water Pressure Recommended: 45.0 psi

INSPIRATION

Pure, timeless, unique and versatile - sculptural organic forms meet advanced engineering in this inspiring collection of fittings, hardware and accessories.

CODES & STANDARDS

PRODUCT FEATURES

Made of Brass

Features a swivel 6" showerhead with easy clean rubber nozzles

Includes a 8" wall mounted 45 degree shower arm

Stocked in Brass, Chrome and Nickel

Showerhead available in 1.75gpm (6.6L/min) flow rate

CERTIFICATIONS

PRODUCT (NOTES)

WATERWORKS

ISLA

ISS265

Isla 6" Showerhead with 8" Wall Mounted 45 Degree Shower Arm

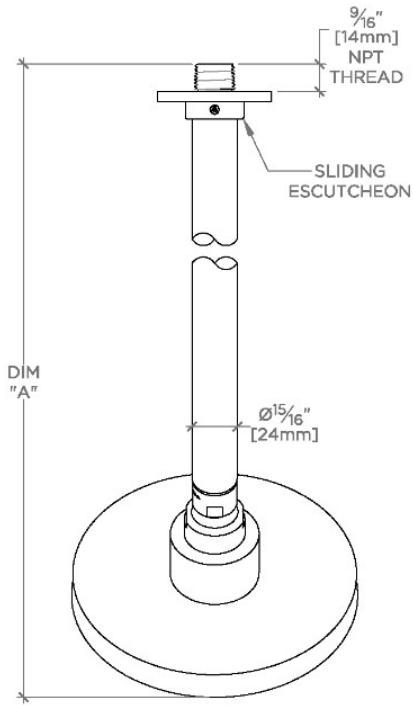

TOP VIEW

SCALE: 3"=1'-0"

STYLE NO.	DIM "A"	DIM "B"
FLS265	12 ¹³ / ₁₆ " [325mm]	8 ¹ / ₄ " [209mm]
ISS265		
FLS266	14 ¹³ / ₁₆ " [376mm]	10 ¹ / ₄ " [260mm]
ISS266		

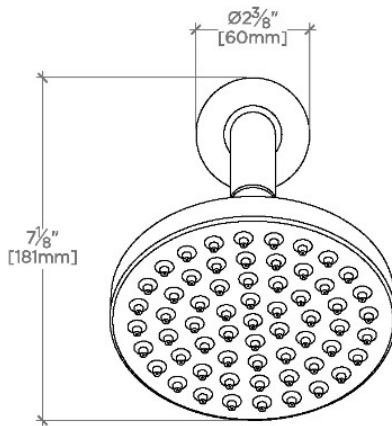

FRONT VIEW

SCALE: 3"=1'-0"

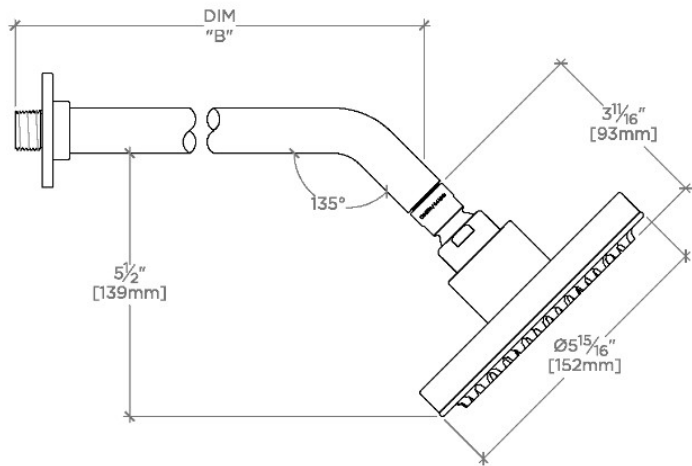

SIDE VIEW

SCALE: 3"=1'-0"