

# LOLLIPOP - FV181.02/J2V

Large vessel height, single handle lavatory set, knurled handle vertical style , with push-down pop-up drain assembly (no lift rod)

Monocomando para lavatorios vessel altos, con volante moleteado estilo vertical y desagüe "push down".

FRANZ  
VIEGENER

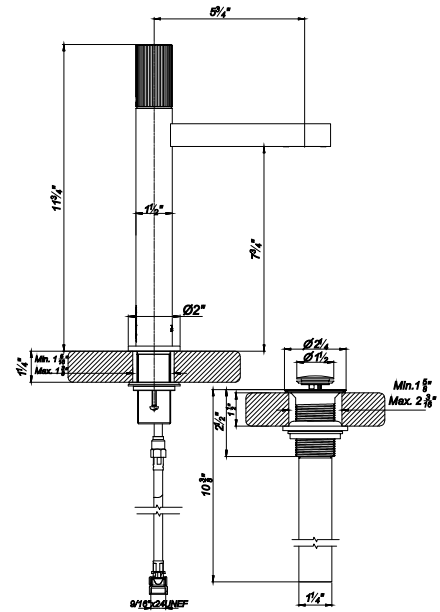









## FEATURES

### CARACTERÍSTICAS

- All brass construction.  
Producto realizado íntegramente en latón.
- Brass valve bodies.  
Cuerpos de válvulas fabricados en latón.
- Stationary spout with recessed aerator device.  
Pico con aireador oculto.
- Flexible SS connectors with sediment screens.  
Flexibles con conectores SS y filtro de sedimento.

## COLOR / FINISHES

### COLOR / ACABADOS

- |  |  |  |
|--|--|--|
|  PC<br>Polished Chrome. |  PN<br>Polished Nickel. |  BN<br>Brushed Nickel.          |
|  BG<br>Brushed Gold.    |  PG<br>Polished Gold.   |  RG<br>Rose Gold.               |
|  BK<br>Black Chrome.    |  FB<br>Flat Black.      |  UPB<br>Unlacked Polished Brass |

## FLOW RATE

### CAUDAL

- Maximum flow rate 1,2 gpm (4,5 l/min).  
Caudal máximo 1,2 gpm (4,5 l/min).

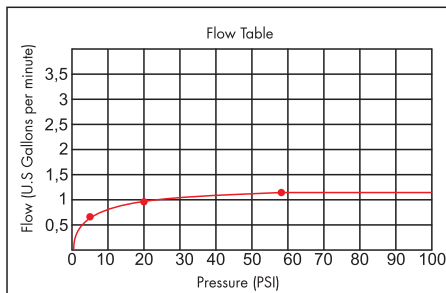

## ITEM DETAILS

### DETALLE DE PRODUCTO

## COMPLIANCE CERTIFICACIONES

